

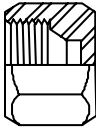
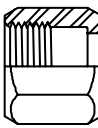
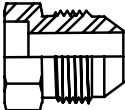

PART NO.	NET EACH	PART NO.	NET EACH	PART NO.	NET EACH
					
37° JIC CAP		37° TUBE NUT		(1) BRAZE TUBE OD (2) 37° MALE	
304-C-2	4.60	318-2	1.60	403-4-4	1.27
304-C-3	4.60	318-3	1.38	403-5-5	6.78
304-C-4	0.76	318-4	0.49	403-6-6	1.60
304-C-5	1.09	318-5	0.76	403-8-8	1.89
304-C-6	0.93	318-6	0.56	403-10-10	2.58
304-C-8	1.69	318-8	0.93	403-12-8	4.71
304-C-10	2.29	318-10	1.29	403-12-12	3.44
304-C-12	3.22	318-12	2.02	403-16-12	7.31
304-C-14	5.73	318-14	5.44	403-16-16	5.11
304-C-16	5.18	318-16	3.76	403-20-16	10.11
304-C-20	9.04	318-20	7.71	403-20-20	7.62
304-C-24	15.18	318-24	12.87	403-24-20	51.72
304-C-32	71.05	318-32	40.78	403-24-24	12.56
				403-32-32	113.82
					
BULKHEAD LOCKNUT		37° TUBE SLEEVE		(1) BRAZE TUBE OD (2) MALE PIPE	
306-4	0.73	319-2	1.20	404-6-4	5.23
306-5	0.93	319-3	0.98	404-8-6	4.93
306-6	0.87	319-4	0.33	404-10-8	4.13
306-8	1.09	319-5	0.67	404-12-8	3.58
306-10	1.67	319-6	0.42	404-12-12	6.76
306-12	2.47	319-8	0.53	404-16-16	9.67
306-14	4.42	319-10	0.69	404-20-16	10.11
306-16	4.22	319-12	1.04	404-20-20	72.94
306-20	4.80	319-14	2.18		
306-24	7.71	319-16	1.98		
306-32	17.62	319-20	4.16		
		319-24	6.80		
		319-32	21.13		

PART NO.	NET EACH	PART NO.	NET EACH	PART NO.	NET EACH
					
(1) BRAZE TUBE OD (2) 37° MALE		(1) MALE PIPE (2) FEMALE PIPE SWIVEL RESTRICTED ORIFICE		(1) MALE PIPE (2) FEMALE PIPE SWIVEL	
500-4-4	4.29	1404-4-4-RO	1.56	1501-2-2	4.24
500-5-5	4.58	1404-6-6-RO	5.92	1501-2-4	5.07
500-6-6	4.13	1404-8-8-RO	7.97	1501-4-2	5.91
500-8-8	7.84			1501-4-4	3.80
500-10-10	6.69			1501-4-6	6.93
500-12-12	9.87	(1) FEMALE PIPE (2) FEMALE PIPE SWIVEL		1501-6-4	5.44
500-14-14	25.27	1405-2-2	2.76	1501-6-6	5.22
500-16-16	16.33	1405-2-4	5.67	1501-6-8	7.73
500-20-20	27.89	1405-4-4	2.93	1501-8-4	8.02
500-24-24	64.11	1405-4-6	5.04	1501-8-6	6.20
		1405-6-4	5.27	1501-8-8	5.69
(1) MALE PIPE (2) FEMALE PIPE SWIVEL		1405-6-6	3.22	1501-8-12	15.20
1404-2-2	2.07	1405-6-8	6.11	1501-12-6	15.20
1404-2-4	3.02	1405-8-6	5.33	1501-12-8	10.33
1404-4-2	3.40	1405-8-8	4.16	1501-12-12	11.09
1404-4-4	2.11	1405-12-12	7.02	1501-12-16	25.00
1404-4-6	3.36	1405-16-12	16.82	1501-16-8	32.40
1404-6-4	3.49	1405-16-16	10.89	1501-16-12	21.18
1404-6-6	2.64	1405-20-20	17.62	1501-16-16	18.42
1404-6-8	4.36	1405-24-24	28.31	1501-16-20	50.16
1404-8-4	6.11	1405-32-32	49.42	1501-20-16	41.80
1404-8-6	4.47			1501-20-20	36.62
1404-8-8	3.44			1501-24-20	63.87
1404-8-12	7.40			1501-24-24	52.36
1404-12-8	6.58			1501-32-32	114.98
1404-12-12	5.49				
1404-12-16	11.40			(1) MALE PIPE - LONG (2) FEMALE PIPE SWIVEL	
1404-16-12	9.44			1501-L-4-4	8.44
1404-16-16	10.22			1501-L-6-6	11.89
1404-16-20	21.07			1501-L-8-8	13.82
1404-20-20	16.25			1501-L-12-12	22.98
1404-20-24	32.62			1501-L-16-16	74.43
1404-24-20	34.91				
1404-24-24	21.89				
1404-32-32	44.20				

PART NO.	NET EACH	PART NO.	NET EACH	PART NO.	NET EACH
		1503-12-8	17.53	1601-12-8	21.49
		1503-12-12	11.20	1601-12-12	20.29
		1503-12-16	28.16	1601-12-16	41.67
		1503-16-12	24.33	1601-16-12	42.93
		1503-16-16	18.20	1601-16-16	37.31
		1503-20-16	33.07	1601-20-20	77.71
		1503-20-20	30.07	1601-24-24	110.18
		1503-24-24	53.60		
		1503-32-32	119.87		
(1) FEMALE PIPE				(1) FEMALE PIPE	
(2) FEMALE PIPE SWIVEL		(1) FEMALE PIPE		(2-3) FEMALE PIPE SWIVEL	
1502-2-2	5.56	1504-2-4	26.07	1602-2-2	10.60
1502-4-2	13.09	1504-4-4	8.24	1602-4-4	11.78
1502-4-4	6.18	1504-6-4	9.98	1602-6-4	13.71
1502-4-6	15.31	1504-6-6	10.44	1602-6-6	12.36
1502-6-4	8.31	1504-8-6	27.98	1602-8-6	15.49
1502-6-6	7.11	1504-8-8	11.98	1602-8-8	15.11
1502-6-8	15.42	1504-12-12	17.27	1602-12-8	29.07
1502-8-4	17.80	1504-16-12	48.09	1602-12-12	21.25
1502-8-6	10.16	1504-16-16	27.47	1602-16-12	39.91
1502-8-8	9.09	1504-20-20	47.98	1602-16-16	46.96
1502-8-12	17.73	1504-24-24	91.60	1602-20-20	94.14
1502-12-8	15.49				
1502-12-12	14.53				
1502-12-16	77.56	(1) MALE PIPE		(1-2-3) FEMALE PIPE SWIVEL	
1502-16-12	28.05	(2) (3) FEMALE PIPE SWIVEL		1603-2-2	13.91
1502-16-16	23.47	1601-2-2	10.18	1603-4-4	11.20
1502-16-16	23.47	1601-4-4	8.71	1603-6-6	11.89
1502-20-20	43.62	1601-4-6	12.47	1603-8-8	13.47
1502-24-24	99.80	1601-6-4	11.89	1603-12-12	33.40
1502-32-32	276.45	1601-6-6	9.02	1603-16-16	73.67
		1601-8-4	15.91	1603-20-20	136.34
		1601-8-6	13.22		
(1) MALE PIPE		1601-8-8	11.71		
(2) FEMALE PIPE SWIVEL					
1503-2-2	4.51				
1503-2-4	9.71				
1503-4-2	14.11				
1503-4-4	4.76				
1503-4-6	11.91				
1503-6-4	9.47				
1503-6-6	6.16				
1503-6-8	12.16				
1503-8-4	13.02				
1503-8-6	9.58				
1503-8-8	7.22				
1503-8-12	20.87				

PART NO.	NET EACH	PART NO.	NET EACH	PART NO.	NET EACH
					
(1) 37° MALE (2) "O" RING FLANGE CODE 61		(1) 37° MALE (2) 45° "O" RING FLANGE CODE 61		(1) 37° MALE (2) 90° "O" RING FLANGE CODE 61	
1700-61-8-8	20.20	1703-61-8-8	26.45	1704-61-8-8	23.71
1700-61-8-12	21.62	1703-61-8-12	47.02	1704-61-8-12	39.51
1700-61-12-12	20.65	1703-61-12-12	32.00	1704-61-12-12	32.85
1700-61-12-16	27.07	1703-61-12-16	43.11	1704-61-12-16	39.80
1700-61-12-20	44.02	1703-61-12-20	61.94	1704-61-12-20	47.27
1700-61-16-12	25.80	1703-61-16-12	85.29	1704-61-16-12	54.89
1700-61-16-16	23.53	1703-61-16-16	36.40	1704-61-16-16	41.73
1700-61-16-24	46.67	1703-61-16-24	60.94	1704-61-16-24	67.78
1700-61-16-20	27.78	1703-61-16-20	67.78	1704-61-20-12	54.34
1700-61-20-16	39.38	1703-61-20-16	71.27	1704-61-20-16	49.07
1700-61-20-20	37.42	1703-61-20-20	51.98	1704-61-20-20	51.65
1700-61-20-24	64.74	1703-61-20-24	67.71	1704-61-20-24	76.65
1700-61-24-20	76.20	1703-61-24-24	83.20	1704-61-24-16	93.65
1700-61-24-24	51.49	1703-61-32-32	122.98	1704-61-24-20	100.16
1700-61-24-32	78.42			1704-61-24-24	78.47
1700-61-32-32	114.65			1704-61-24-32	150.89
				1704-61-32-32	141.16
					
(1) 37° MALE (2) "O" RING FLANGE CODE 62		(1) 37° MALE (2) 45° "O" RING FLANGE CODE 62		(1) 37° MALE (2) 90° "O" RING FLANGE CODE 62	
1700-62-12-12	38.40	1703-62-12-12	57.89	1704-62-12-12	56.38
1700-62-12-16	50.54	1703-62-12-16	79.45	1704-62-12-16	67.89
1700-62-16-12	43.25	1703-62-16-12	79.45	1704-62-12-20	74.20
1700-62-16-16	52.65	1703-62-16-16	74.58	1704-62-16-12	67.67
1700-62-16-20	57.34	1703-62-16-20	78.29	1704-62-16-16	50.94
1700-62-16-24	146.94	1703-62-16-24	137.58	1704-62-16-20	72.40
1700-62-20-16	66.56	1703-62-20-16	85.89	1704-62-16-24	138.18
1700-62-20-20	70.62	1703-62-20-20	81.83	1704-62-20-16	71.98
1700-62-20-24	88.11	1703-62-20-24	104.29	1704-62-20-20	85.51
1700-62-24-20	80.29	1703-62-24-20	104.00	1704-62-20-24	113.76
1700-62-24-24	81.45	1703-62-24-24	102.83	1704-62-24-16	110.43
1700-62-32-32	116.27	1703-62-32-32	206.83	1704-62-24-20	110.43
				1704-62-24-24	114.52
				1704-62-24-32	158.34
				1704-62-32-32	205.07

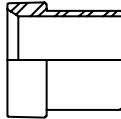
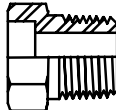
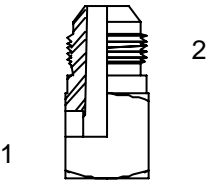
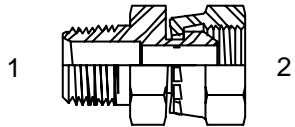
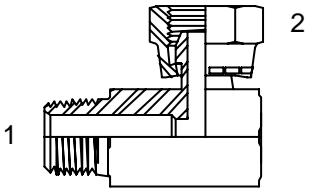
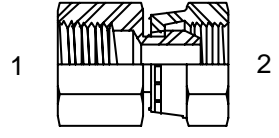
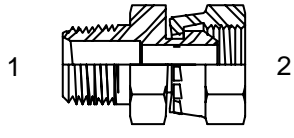
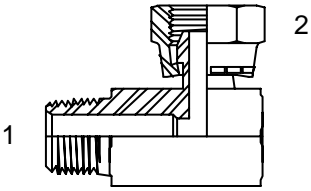
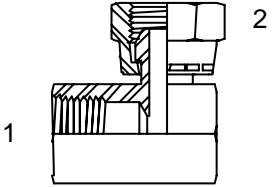
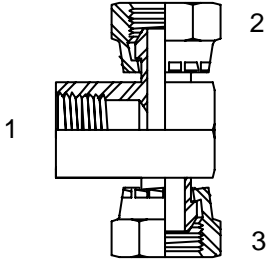
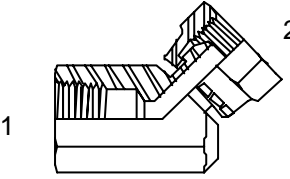
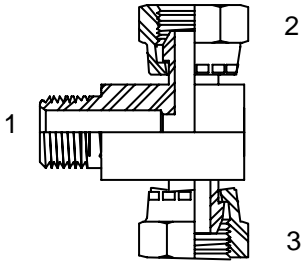
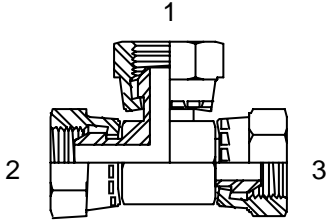
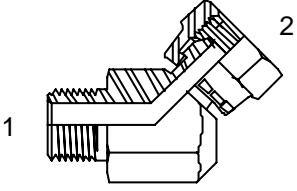
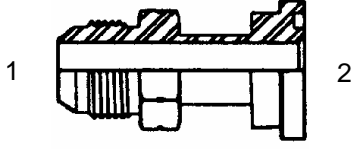
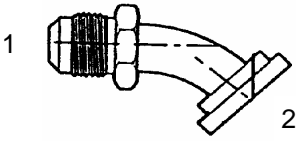
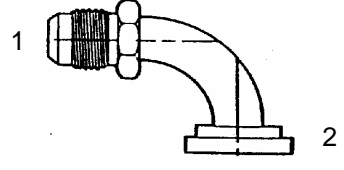
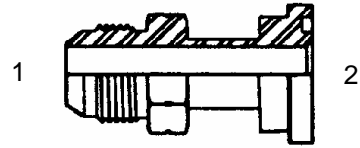
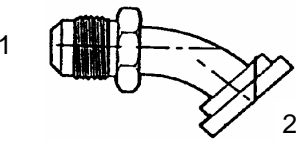
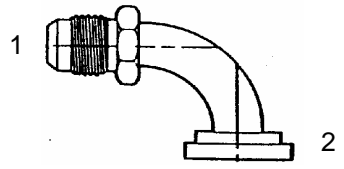
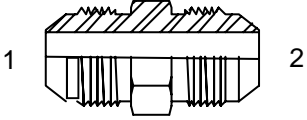
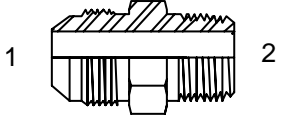
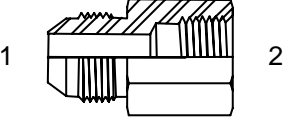
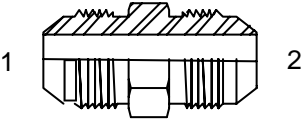
PART NO.	NET EACH	PART NO.	NET EACH	PART NO.	NET EACH
 <p>(1) 37° MALE (2) 37° MALE</p>		 <p>(1) 37° MALE (2) MALE PIPE</p>		 <p>(1) 37° MALE (2) FEMALE PIPE</p>	
2403-2-2	20.67	2404-2-2	3.69	2405-4-2	1.73
2403-3-3	10.20	2404-3-2	2.36	2405-4-4	2.67
2403-4-2	19.38	2404-4-2	0.93	2405-5-2	3.20
2403-4-3	19.38	2404-4-4	1.22	2405-5-4	3.33
2403-4-4	1.73	2404-4-6	2.33	2405-6-4	2.38
2403-5-4	6.56	2404-4-8	5.89	2405-6-6	2.89
2403-5-5	2.13	2404-5-2	1.69	2405-6-8	8.78
2403-6-4	2.56	2404-5-4	1.76	2405-8-6	3.04
2403-6-5	12.84	2404-5-6	2.67	2405-8-8	4.42
2403-6-6	1.60	2404-6-2	1.67	2405-8-12	15.59
2403-8-6	2.91	2404-6-4	1.22	2405-10-6	6.38
2403-8-8	2.18	2404-6-6	1.62	2405-10-8	4.73
2403-10-8	3.76	2404-6-8	2.62	2405-10-12	57.19
2403-10-10	2.87	2404-6-12	10.76	2405-12-8	9.07
2403-12-8	5.51	2404-8-4	2.73	2405-12-12	6.76
2403-12-10	5.71	2404-8-6	1.93	2405-14-12	12.42
2403-12-12	4.38	2404-8-8	1.98	2405-16-12	11.07
2403-14-12	19.76	2404-8-12	4.51	2405-16-16	9.87
2403-14-14	7.58	2404-8-16	43.25	2405-20-20	18.18
2403-16-12	9.91	2404-10-6	3.31	2405-24-24	40.65
2403-16-16	6.53	2404-10-8	3.16	2405-32-32	104.29
2403-20-16	18.98	2404-10-12	5.27		
2403-20-20	11.04	2404-12-6	6.97		
2403-24-16	107.71	2404-12-8	4.64		
2403-24-20	76.55	2404-12-12	3.62		
2403-24-24	23.33	2404-12-16	6.27		
2403-32-32	96.23	2404-12-20	28.25		
 <p>(1) 37° LARGE HEX (2) 37° LARGE HEX</p>		2404-14-12	6.76		
		2404-16-12	6.64		
		2404-16-16	5.67		
		2404-16-20	11.07		
		2404-16-24	64.27		
		2404-20-12	63.91		
		2404-20-16	12.64		
		2404-20-20	10.67		
		2404-20-24	22.13		
		2404-20-32	125.51		
		2404-24-20	22.76		
		2404-24-24	16.22		
		2404-24-32	133.71		
		2404-32-20	125.51		
		2404-32-24	129.11		
		2404-32-32	51.69		
2403-LH-4-4	2.87				
2403-LH-6-6	3.00				
2403-LH-8-8	3.31				
2403-LH-10-10	6.49				
2403-LH-12-12	7.80				
2403-LH-16-16	14.76				
2403-LH-20-20	26.42				
2403-LH-24-24	65.14				

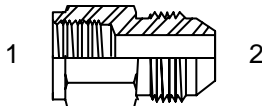
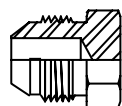
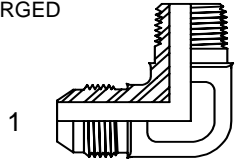
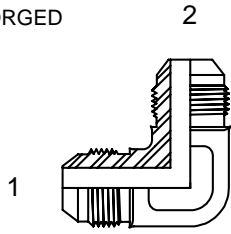

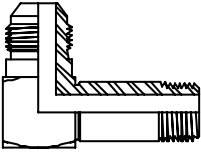
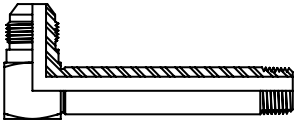
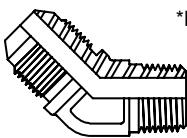
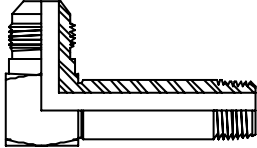
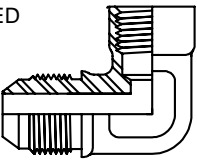
PART NO.	NET EACH	PART NO.	NET EACH	PART NO.	NET EACH
					
(1) 37° FEMALE (2) 37° MALE		37° PLUG		*FORGED (1) 37° MALE (2) MALE PIPE	
2406-4-6	5.73	2408-2	13.53	2501-2-2*	11.94
2406-5-4	13.04	2408-3	12.13	2501-3-2	7.80
2406-6-4	2.67	2408-4	0.87	2501-4-2*	2.91
2406-6-5	19.98	2408-5	1.49	2501-4-4*	3.42
2406-6-8	7.51	2408-6	1.20	2501-4-6*	5.09
2406-8-4	5.29	2408-8	1.64	2501-4-8*	6.64
2406-8-5	26.77	2408-10	2.38	2501-5-2*	4.20
2406-8-6	3.42	2408-12	3.64	2501-5-4*	4.20
2406-8-10	8.82	2408-14	9.07	2501-5-6	7.33
2406-8-12	10.24	2408-16	5.22	2501-6-2*	4.20
2406-10-4	8.69	2408-20	9.69	2501-6-4*	3.47
2406-10-6	6.82	2408-24	26.60	2501-6-6*	4.47
2406-10-8	4.13	2408-32	70.09	2501-6-8*	6.18
2406-10-12	10.80			2501-8-4*	5.67
2406-12-4	9.51	*FORGED		2501-8-6*	5.09
2406-12-6	8.71			2501-8-8*	5.76
2406-12-8	6.53	(1) 37° MALE (2) 37° MALE		2501-8-12*	9.16
2406-12-10	6.93			2501-8-16	23.07
2406-12-16	11.76			2501-10-6*	7.73
2406-14-6	27.45			2501-10-8*	6.44
2406-14-8	21.13			2501-10-12*	10.56
2406-14-10	17.42			2501-12-6	13.62
2406-14-12	14.51			2501-12-8	10.51
2406-16-4	54.45			2501-12-12*	8.98
2406-16-6	32.56	2500-4-4*	3.16	2501-12-16*	15.51
2406-16-8	14.04	2500-5-5*	5.31	2501-14-12	23.60
2406-16-10	16.20	2500-6-4	6.02	2501-16-12	15.42
2406-16-12	11.58	2500-6-6*	3.98	2501-16-16*	15.11
2406-16-12	11.58	2500-8-6	9.80	2501-16-20*	30.71
2406-16-14	19.16	2500-8-8*	5.82	2501-20-16	34.11
2406-16-20	43.18	2500-10-8	11.98	2501-20-20*	30.05
2406-20-8	74.82	2500-10-10*	8.69	2501-20-24*	50.73
2406-20-12	23.45	2500-12-10	19.18	2501-24-16	76.26
2406-20-16	21.96	2500-12-12*	11.07	2501-24-20	54.65
2406-20-24	113.67	2500-14-14	41.53	2501-24-24*	44.13
2406-24-12	114.98	2500-16-16*	18.29	2501-32-32	136.23
2406-24-16	87.23	2500-20-20*	32.67		
2406-24-20	52.91	2500-24-24	45.09		
2406-24-32	287.54	2500-32-32	227.72		
2406-32-24	170.18				

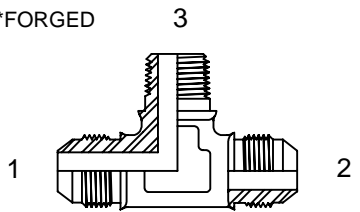
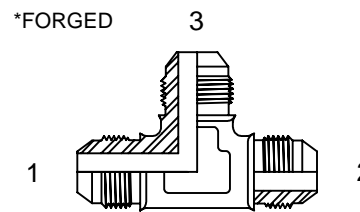
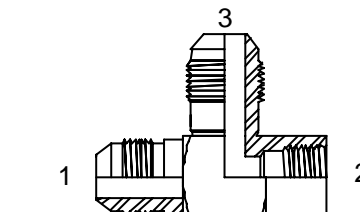
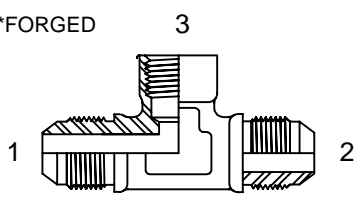
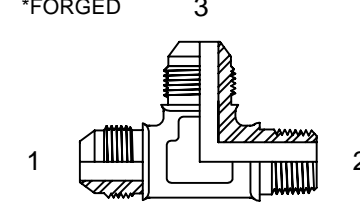
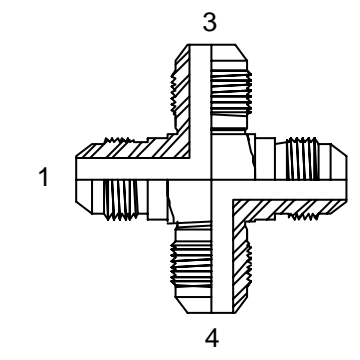
PART NO.	LIST EACH	PART NO.	LIST EACH	PART NO.	LIST EACH
1		1		1	
	2		2		2
(1) 37° MALE (2) MALE PIPE LONG		(1) 37° MALE (2) MALE PIPE XX-LONG		(1) 37° MALE (2) MALE PIPE	
2501-L-4-2	4.91	2501-L-4-2	8.60	2503-2-2*	18.53
2501-L-4-4	5.38	2501-L-4-4	15.14	2503-3-2*	17.47
2501-L-5-2	8.09	2501-L-5-2	29.41	2503-4-2*	3.76
2501-L-5-4	8.82			2503-4-4*	4.38
2501-L-6-4	6.31			2503-4-6	8.31
2501-L-6-6	9.29			2503-5-2*	10.47
2501-L-8-6	8.13			2503-5-4*	7.40
2501-L-8-8	12.20			2503-6-2*	9.44
2501-L-8-12	22.02			2503-6-4*	4.56
2501-L-10-8	13.64			2503-6-6*	5.24
2501-L-10-12	19.42			2503-6-8*	7.22
2501-L-12-8	17.11			2503-8-4*	7.40
2501-L-12-12	16.91			2503-8-6*	5.71
2501-L-14-12	23.05			2503-8-8*	7.09
2501-L-16-12	27.49			2503-8-12	13.07
2501-L-16-16	27.29			2503-10-6*	11.00
2501-L-20-20	96.43			2503-10-8*	7.62
2501-L-24-24	152.96			2503-10-12*	12.49
				2503-12-8*	13.76
				2503-12-12*	11.04
				2503-12-16	17.69
				2503-14-12	36.00
				2503-16-12*	19.60
				2503-16-16*	14.84
				2503-20-20*	27.29
				2503-24-24*	40.69
				2503-32-32*	130.25
1		1			
	2		2		
(1) 37° MALE (2) MALE PIPE X-LONG		(1) 37° MALE (2) FEMALE PIPE			
2501-LL-4-2	6.20	2502-4-2*	4.02		
2501-LL-4-4	6.76	2502-4-4*	4.40		
2501-LL-5-2	7.80	2502-5-2	7.11		
2501-LL-5-4	10.96	2502-5-4	7.73		
2501-LL-6-4	6.13	2502-6-2	7.04		
2501-LL-6-6	10.16	2502-6-4*	5.04		
2501-LL-6-8	18.87	2502-6-6*	6.93		
2501-LL-8-6	9.07	2502-6-8	13.80		
2501-LL-8-8	12.84	2502-8-4	13.13		
2501-LL-10-8	13.24	2502-8-6*	7.51		
2501-LL-12-8	37.71	2502-8-8*	8.80		
2501-LL-12-12	20.53	2502-10-8*	11.87		
2501-LL-14-12	22.53	2502-10-12	15.69		
2501-LL-16-16	33.71	2502-12-8	23.89		
2501-LL-16-12	32.53	2502-12-12*	14.60		
2501-LL-20-20	165.05	2502-14-12	34.71		
		2502-16-12	27.67		
		2502-16-16*	24.38		
		2502-20-20*	40.42		
		2502-24-24	78.38		
		2502-32-32	372.95		

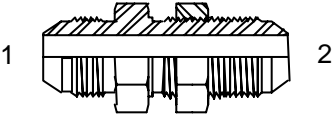
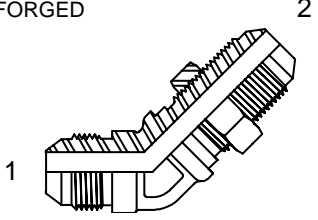
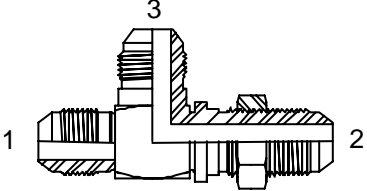
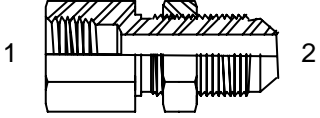
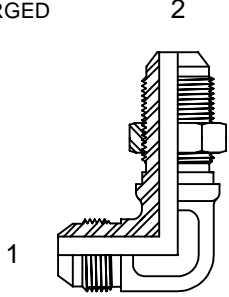
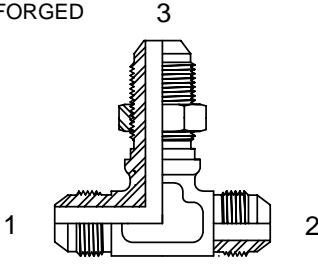
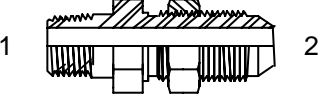
PART NO.	LIST EACH	PART NO.	LIST EACH	PART NO.	LIST EACH
*FORGED		*FORGED			
					
(1-2) 37° MALE (3) MALE PIPE		(1-2-3) 37° MALE		(1-3) 37° MALE (2) FEMALE PIPE	
2601-4-2*	5.62	2603-4*	4.73	2606-4-2	19.45
2601-4-4*	6.58	2603-5*	7.11	2606-6-4	10.60
2601-5-2	12.42	2603-6*	5.22	2606-8-6	14.96
2601-5-4	11.76	2603-6-6-8	11.89	2606-10-8	19.45
2601-6-4*	6.02	2603-8*	7.62	2606-12-12	31.71
2601-6-6*	9.22	2603-10*	10.47	2606-14-12	97.98
2601-6-8	16.69	2603-12-12-8	17.42	2606-16-16	93.34
2601-8-6*	8.24	2603-12*	13.84		
2601-8-8*	9.87	2603-14*	49.07		
2601-10-8*	11.24	2603-16-12-12	37.07		
2601-12-12*	15.69	2603-16*	23.00		
2601-14-12	50.98	2603-20*	63.91		
2601-16-12	33.33	2603-24*	91.96		
2601-16-16*	25.49	2603-32	373.61		
2601-20-20	68.69				
2601-24-24	113.58				
2601-32-32	396.12				
*FORGED		*FORGED			
					
(1-2) 37° MALE (3) FEMALE PIPE		(1-3) 37° MALE (2) MALE PIPE		(1-2-3-4) 37° MALE	
2602-4-2*	7.40	2605-4-2*	6.42	2650-4	11.40
2602-4-4	8.67	2605-4-4*	6.49	2650-5	15.36
2602-5-2	12.89	2605-5-2	13.76	2650-6	12.27
2602-6-4*	9.29	2605-5-4	15.02	2650-8	13.24
2602-6-6*	9.87	2605-6-2	11.98	2650-10	20.80
2602-8-6*	11.18	2605-6-4*	6.09	2650-12	25.73
2602-8-8	13.71	2605-6-6*	8.44	2650-14	64.78
2602-10-8	15.82	2605-8-6*	9.27	2650-16	39.56
2602-12-8	32.47	2605-8-8*	10.40	2650-20	91.27
2602-12-12	23.05	2605-10-8*	13.31	2650-24	143.16
2602-14-12	48.49	2605-12-12*	15.47		
2602-16-16	39.49	2605-14-12	44.73		
2602-20-20	62.02	2605-16-16*	27.53		
2602-24-24	112.94	2605-20-20*	51.62		
2602-32-32	502.73	2605-24-24*	78.89		
		2605-32-32	343.30		

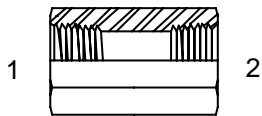
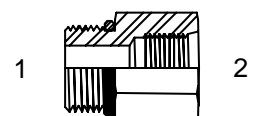
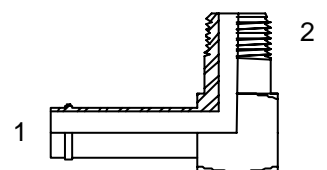
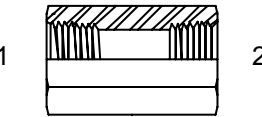
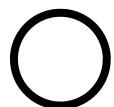
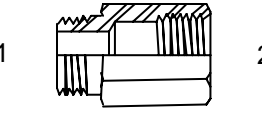
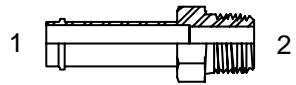
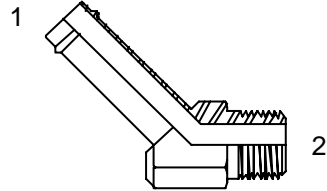
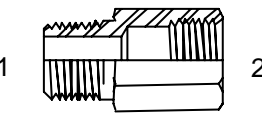
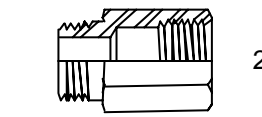
PART NO.	LIST EACH	PART NO.	LIST EACH	PART NO.	LIST EACH	
		*FORGED				
(1) 37° MALE (2) 37° BULKHEAD		(1) 37° MALE (2) 37° BULKHEAD		(1-3) 37° MALE (2) 37° BULKHEAD		
2700-4-4	4.51	2702-4-4*	8.18	2704-4-4	9.64	
2700-5-5	8.47	2702-5-5*	16.05	2704-6-6	11.84	
2700-6-6	4.02	2702-6-6*	9.13	2704-8-8	15.16	
2700-8-8	5.36	2702-8-8*	10.42	2704-10-10	25.89	
2700-10-10	7.69	2702-10-10*	15.89	2704-12-12	31.11	
2700-12-12	10.40	2702-12-12*	20.85	2704-16-16	53.78	
2700-14-14	23.22	2702-16-16*	36.73			
2700-16-16	17.00	2702-20-20	139.59			
2700-20-20	28.49			(1) FEMALE PIPE (2) 37° BULKHEAD		
2700-24-24	37.85			2705-2-4	7.13	
		*FORGED			2705-4-4	10.20
		(1) 37° MALE (2) 37° BULKHEAD		(1-2) 37° MALE (3) 37° BULKHEAD	2705-4-6	8.73
					2705-6-6	13.80
					2705-6-8	11.51
					2705-8-8	15.04
					2705-8-10	17.00
					2705-12-12	19.91
					2705-16-16	27.33
						
				(1) MALE PIPE (2) 37° BULKHEAD		
2701-4-4*	5.33	2703-4-4*	9.78	2706-2-4	11.82	
2701-5-5*	11.69	2703-5-5	40.89	2706-4-4	12.73	
2701-6-6*	5.84	2703-6-6*	10.18	2706-4-6	8.69	
2701-8-8*	8.96	2703-8-8*	14.58	2706-6-6	11.71	
2701-10-10*	12.11	2703-10-10*	26.51	2706-6-8	11.31	
2701-12-12*	17.67	2703-12-12*	32.20	2706-8-8	14.20	
2701-16-16*	30.33	2703-16-16*	37.05	2706-8-10	13.87	
2701-20-20*	64.49			2706-8-10	13.87	
				2706-12-12	22.33	
				2706-16-16	28.78	
				2706-20-20	75.40	
				2706-24-24	141.52	

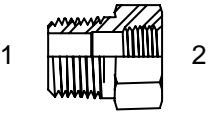
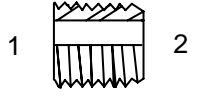
PART NO.	LIST EACH	PART NO.	LIST EACH	PART NO.	LIST EACH
					
(1) FEMALE "O" RING (2) FEMALE PIPE		(1) MALE "O" RING (2) FEMALE CASE		(1) BEADED STEM (2) MALE PIPE	
3303-8-6 6.71 3303-8-8 6.56 3303-10-8 6.67		3404-10-10 5.24		4501-8-8 8.82 4501-10-8 7.58 4501-10-12 10.78 4501-12-8 8.67 4501-12-12 9.87 4501-12-16 19.20 4501-16-12 17.31 4501-16-16 16.29 4501-20-16 28.05 4501-20-20 30.27 4501-24-24 52.69 4501-32-32 370.35	
					
(1) FEMALE "O" RING (2) FEMALE "O" RING		SAE J515 a BUNA-N "O" RINGS			
3304-8-8 6.31 3304-10-10 6.98		4000-4 0.20 4000-5 0.27 4000-6 0.27 4000-8 0.40 4000-10 0.53 4000-12 0.67 4000-14 0.80 4000-16 0.87 4000-20 1.33 4000-24 1.53 4000-32 2.13			
					
(1) 7/8-18 MALE CASE (2) FEMALE PIPE		(1) BEADED STEM (2) MALE PIPE		(1) BEADED STEM (2) MALE PIPE	
3401-10-8 5.71		4404-6-6 4.18 4404-10-8 4.98 4404-12-8 7.58 4404-12-12 7.04 4404-16-16 9.80 4404-16-12 12.62 4404-20-20 19.71 4404-24-24 33.07 4404-24-20 39.49 4404-32-32 264.56		4503-10-8 5.51 4503-12-8 9.18 4503-12-12 10.44 4503-16-12 14.67 4503-16-16 14.67 4503-20-20 24.60 4503-24-24 55.67	
					
(1) MALE PIPE (2) 7/8-18 FEMALE CASE					
3402-10-8 5.89					
					
(1) 7/8-18 MALE CASE (2) FEMALE "O" RING					
3403-10-10 5.62					

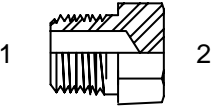
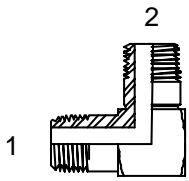
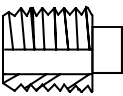
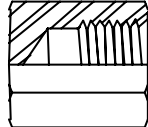
PART NO.	LIST EACH	PART NO.	LIST EACH	PART NO.	LIST EACH
 <p>(1) MALE PIPE BUSHING (2) FEMALE PIPE</p>		 <p>(1) MALE PIPE (2) FEMALE PIPE FLAT HEAD BUSHING</p>		 <p>COUNTERSUNK PIPE PLUG</p>	
5406-H-4-2	1.58	5406-4-2FB	1.11	5409-1	0.47
5406-H-6-2	2.34	5406-8-2FB	2.29	5409-2	0.40
5406-H-6-4	1.85	5406-8-4FB	2.29	5409-4	0.36
5406-H-8-2	4.41	5406-8-6FB	2.29	5409-6	0.44
5406-H-8-4	2.34	5406-12-2FB	3.27	5409-8	0.67
5406-H-8-6	2.07	5406-12-4FB	3.27	5409-12	1.07
5406-H-12-2	11.73	5406-12-6FB	3.27	5409-16	2.49
5406-H-12-4	3.32	5406-12-8FB	3.27	5409-20	4.53
5406-H-12-6	3.49	5406-16-6FB	6.02	5409-24	11.67
5406-H-12-8	3.43	5406-16-8FB	6.02	5409-32	18.62
5406-H-16-4	10.51	5406-16-12FB	6.02		
5406-H-16-6	5.39				
5406-H-16-8	5.50	 <p>HEX HEAD PIPE PLUG</p>		 <p>(1) MALE PIPE (2) MALE PIPE</p>	
5406-H-16-12	4.90	5406-2P	0.40	5500-2-2	3.49
5406-H-20-6	18.19	5406-4P	0.49	5500-4-2	5.22
5406-H-20-8	11.89	5406-6P	0.93	5500-4-4	3.80
5406-H-20-12	10.82	5406-8P	1.47	5500-6-4	6.42
5406-H-20-16	9.67	5406-12P	3.16	5500-6-6	5.24
5406-H-24-12	21.27	5406-16P	5.11	5500-8-6	7.51
5406-H-24-16	18.13	5406-20P	9.87	5500-8-8	6.93
5406-H-24-20	17.42	5406-24P	14.27	5500-12-8	12.47
5406-H-32-12	51.36	5406-32P	27.47	5500-12-12	11.91
5406-H-32-16	38.47			5500-16-12	19.91
5406-H-32-20	33.45	 <p>SQUARE HEAD PIPE PLUG</p>		5500-16-16	19.82
5406-H-32-24	33.80	5406-1SQ	0.44	5500-20-20	38.25
		5406-2SQ	0.27	5500-24-24	62.05
		5406-4SQ	0.38	5500-32-32	191.19
		5406-6SQ	0.58		
		5406-8SQ	1.02		
		5406-12SQ	1.53		
		5406-16SQ	5.71		
		5406-20SQ	12.40		
		5406-24SQ	15.20		
		5406-32SQ	25.76		
 <p>FEMALE PIPE CAP</p>					
5406-2C	1.20				
5406-4C	1.58				
5406-6C	2.16				
5406-8C	3.16				
5406-12C	5.09				
5406-16C	8.31				

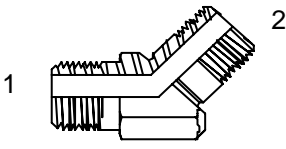
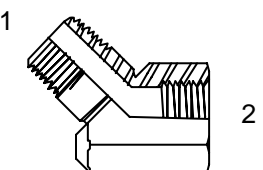
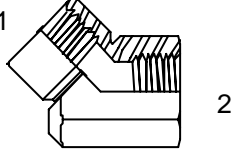
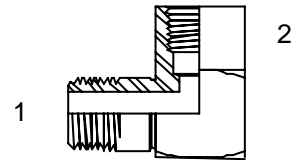
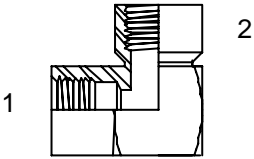
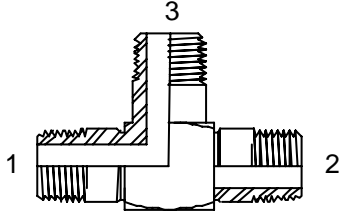
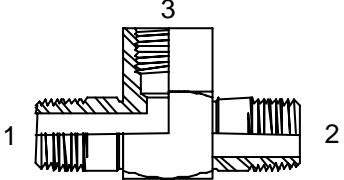
PART NO.	LIST EACH	PART NO.	LIST EACH	PART NO.	LIST EACH
 <p>(1) MALE PIPE (2) MALE PIPE</p>		 <p>(1) MALE PIPE (2) FEMALE PIPE</p>		 <p>(1) FEMALE PIPE (2) FEMALE PIPE</p>	
5501-2-2	7.22	5503-2-2	5.76	5505-2-2	8.36
5501-4-4	6.62	5503-2-4	15.82	5505-4-4	9.11
5501-6-6	9.07	5503-4-4	5.62	5505-6-6	9.98
5501-8-8	10.82	5503-6-6	6.84	5505-8-8	14.33
5501-12-12	16.71	5503-8-8	10.00	5505-12-12	15.64
5501-16-16	23.80	5503-12-12	14.87	5505-16-16	28.56
5501-20-20	89.57	5503-16-16	27.22		
5501-24-24	124.44	5503-20-20	62.42		
		5503-24-24	206.59		
 <p>(1) MALE PIPE (2) FEMALE PIPE</p>		 <p>(1) FEMALE PIPE (2) FEMALE PIPE</p>		 <p>(1-2-3) MALE PIPE</p>	
5502-2-2	3.71	5504-2-2	4.20	5600-4-4	12.04
5502-2-4	4.78	5504-4-2	6.02	5600-6-6	15.22
5502-4-2	4.62	5504-4-4	4.84	5600-8-8	15.93
5502-4-4	4.58	5504-6-4	6.93	5600-12-12	24.82
5502-4-6	6.31	5504-6-6	6.31	5600-16-16	60.34
5502-6-4	5.91	5504-8-6	11.80		
5502-6-6	5.71	5504-8-8	10.29		
5502-6-8	9.76	5504-12-8	19.18		
5502-8-6	8.42	5504-12-12	15.47		
5502-8-8	8.78	5504-16-16	24.40		
5502-8-12	16.11	5504-20-20	40.71		
5502-12-8	14.73	5504-24-24	76.51		
5502-12-12	13.31	5504-32-32	287.63		
5502-12-16	32.64			 <p>(1-2) MALE PIPE (3) FEMALE PIPE</p>	
5502-16-12	26.14			5601-2-2	11.00
5502-16-16	23.18			5601-4-4	11.91
5502-20-20	44.33			5601-6-6	13.07
5502-20-24	98.65			5601-8-8	19.69
5502-24-24	82.09			5601-12-12	27.91
5502-32-32	299.25			5601-16-16	45.98

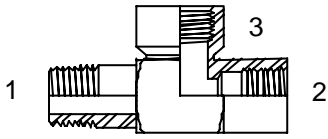
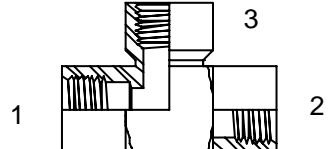
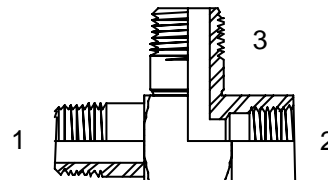
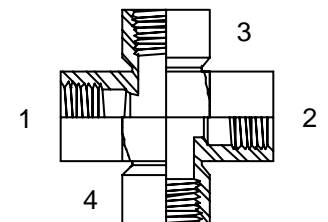
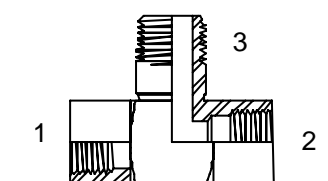
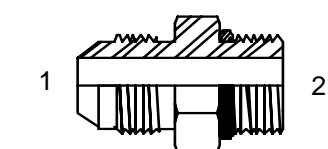
PART NO.	LIST EACH	PART NO.	LIST EACH	PART NO.	LIST EACH
				6400-4-6	2.07
(1) MALE PIPE		(1-2-3) FEMALE PIPE		6400-4-8	4.71
(2-3) FEMALE PIPE				6400-4-10	12.56
5602-2-2	4.82	5605-2-2	5.11	6400-5-4	4.02
5602-4-4	5.78	5605-4-4	6.00	6400-5-5	2.80
5602-6-6	8.62	5605-6-6	8.47	6400-5-6	3.20
5602-8-8	14.27	5605-8-8	12.36	6400-6-4	2.07
5602-12-12	19.98	5605-12-12	18.16	6400-6-5	2.93
5602-16-16	34.96	5605-16-16	31.31	6400-6-6	1.71
5602-20-20	80.16	5605-20-20	60.34	6400-6-8	2.62
5602-24-24	141.14	5605-24-24	117.74	6400-6-10	3.84
5602-32-32	379.75	5605-32-32	400.10	6400-6-12	7.58
				6400-8-4	6.60
(1-3) MALE PIPE		(1-2-3-4) FEMALE PIPE		6400-8-6	2.87
(1) FEMALE PIPE				6400-8-8	2.42
5603-2-2	6.82	5652-2	11.64	6400-8-10	3.20
5603-4-4	6.82	5652-4	10.60	6400-8-12	5.44
5603-6-6	9.76	5652-6	13.02	6400-8-16	14.33
5603-8-8	16.16	5652-8	19.42	6400-10-6	7.11
5603-12-12	22.76	5652-12	29.29	6400-10-8	3.36
5603-16-16	45.40	5652-16	53.56	6400-10-10	3.51
5603-20-20	94.07	5652-20	85.83	6400-10-12	5.64
5603-24-24	171.29	5652-24	186.76	6400-10-16	9.62
				6400-10-20	105.85
(1-2) FEMALE PIPE		(1) 37° MALE		6400-12-8	4.82
(3) MALE PIPE		(2) MALE "O" RING		6400-12-10	4.87
5604-2-2	5.22	6400-2-2	10.84	6400-12-12	4.78
5604-4-4	6.53	6400-3-3	5.18	6400-12-14	8.31
5604-6-6	9.76	6400-4-2	7.67	6400-12-16	8.33
5604-8-8	13.93	6400-4-3	4.71	6400-12-20	22.00
5604-12-12	19.69	6400-4-4	1.53	6400-12-24	80.23
5604-16-16	33.29	6400-4-5	3.02	6400-14-12	16.38
5604-20-20	64.27			6400-14-14	8.89
5604-24-24	131.23			6400-14-16	14.53
				6400-16-10	11.09
				6400-16-12	7.29
				6400-16-14	13.09
				6400-16-16	7.47
				6400-16-20	13.91
				6400-16-24	26.56
				6400-20-12	61.25
				6400-20-16	14.16
				6400-20-20	14.49
				6400-20-24	32.05
				6400-24-20	29.49
				6400-24-24	21.38
				6400-24-32	180.18
				6400-32-24	139.36
				6400-32-32	86.49

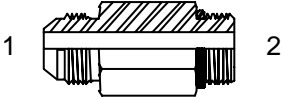
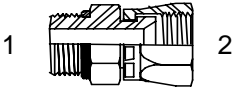
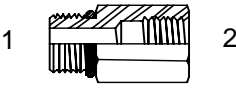
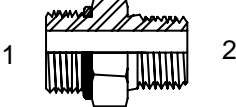
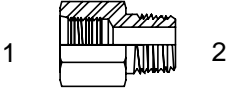
PART NO.	LIST EACH	PART NO.	LIST EACH	PART NO.	LIST EACH
					
(1) 37° MALE LONG		(1) MALE "O" RING		(1) MALE "O" RING	
(2) MALE "O" RING		(2) 37° FEMALE SWIVEL		(2) FEMALE PIPE	
6400-L-4-4	7.84	6402-4-4	6.02	6405-4-2	2.42
6400-L-5-5	25.07	6402-4-6	7.58	6405-4-4	3.76
6400-L-6-6	8.09	6402-6-6	6.00	6405-5-2	3.31
6400-L-8-8	9.80	6402-8-8	6.53	6405-5-4	11.01
6400-L-10-10	13.02	6402-10-8	16.47	6405-6-2	3.49
6400-L-12-12	21.16	6402-10-10	9.36	6405-6-4	2.53
6400-L-14-14	116.49	6402-12-12	11.18	6405-6-6	4.27
6400-L-16-16	53.20	6402-16-16	17.89	6405-8-4	6.09
6400-L-20-20	106.96	6402-20-20	44.60	6405-8-6	3.38
		6402-24-24	167.05	6405-8-8	5.11
				6405-10-6	3.36
				6405-10-8	5.16
				6405-10-12	10.16
				6405-12-6	10.25
				6405-12-8	7.78
				6405-12-12	7.40
				6405-12-16	24.07
				6405-14-12	10.27
				6405-16-8	12.40
				6405-16-12	9.67
				6405-16-16	10.78
				6405-20-12	16.40
				6405-20-20	17.49
				6405-20-16	15.13
				6405-20-24	63.51
				6405-24-16	54.42
				6405-24-20	54.42
				6405-24-24	63.51
				6405-32-32	103.80
					
(1) MALE "O" RING		(1) FEMALE "O" RING			
(2) MALE PIPE		(2) MALE PIPE			
6401-4-2	3.04	6404-4-2	7.18		
6401-4-4	3.96	6404-4-4	7.89		
6401-5-2	2.18	6404-5-2	12.98		
6401-6-2	15.10	6404-6-4	7.13		
6401-6-4	2.69	6404-6-6	5.31		
6401-6-6	5.04	6404-8-6	5.80		
6401-8-6	3.89	6404-8-8	5.07		
6401-8-8	4.13	6404-10-6	43.24		
6401-8-12	12.74	6404-10-8	7.64		
6401-10-8	5.04	6404-12-12	14.73		
6401-12-6	36.68	6404-16-16	31.02		
6401-12-8	11.60	6404-20-20	82.88		
6401-12-12	6.40	6404-24-24	91.54		
6401-12-16	25.86				
6401-16-16	10.98				
6401-20-20	15.62				
6401-24-24	63.27				
6401-32-32	160.54				

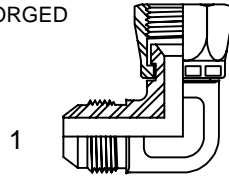
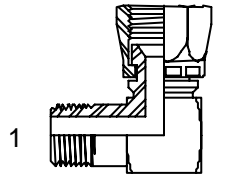
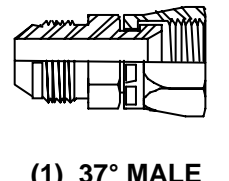
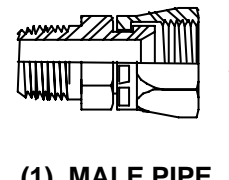
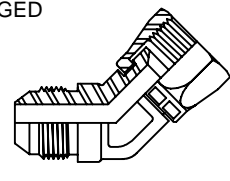
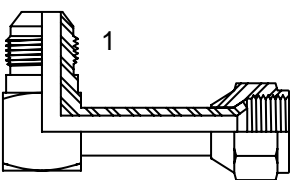
PART NO.	LIST EACH	PART NO.	LIST EACH	PART NO.	LIST EACH
*FORGED					
	2		2		2
(1) 37° MALE (2) 37° FEMALE SWIVEL		(1) MALE PIPE (2) 37° FEMALE SWIVEL		(1) 37° MALE (2) 37° FEMALE SWIVEL	
6500-4-4*	4.64	6501-2-4	4.80	6504-4-4	7.18
6500-5-5*	6.76	6501-4-4	8.33	6504-6-6	7.47
6500-6-4	7.69	6501-4-6	6.00	6504-8-8	8.76
6500-6-5	10.31	6501-6-6	7.91	6504-10-10	11.02
6500-6-6*	5.00	6501-6-8	8.31	6504-12-12	14.44
6500-6-8*	12.65	6501-8-8	8.82	6504-16-16	17.53
6500-8-6*	9.69	6501-8-10	10.29	6504-20-20	33.91
6500-8-8*	7.38	6501-12-12	14.84		
6500-8-10*	12.04	6501-12-14	14.84		
6500-8-12	24.04	6501-16-16	24.47		
6500-10-8	13.00	6501-20-20	53.25		2
6500-10-10*	10.24	6501-24-24	75.96	(1) MALE PIPE (2) 37° FEMALE SWIVEL	
6500-10-12	32.28	6501-32-32	416.70	6505-2-4	5.58
6500-12-8	23.56			6505-4-4	4.78
6500-12-12*	13.69	*FORGED	2	6505-4-5	16.11
6500-14-14*	28.93		2	6505-4-6	5.73
6500-16-16*	23.22	(1) 37° MALE (2) 37° FEMALE SWIVEL		6505-6-6	4.98
6500-20-20*	42.71	6502-4-4*	6.13	6505-6-8	7.44
6500-24-24*	66.27	6502-5-5*	11.11	6505-8-8	5.69
6500-32-32	317.19	6502-6-6*	6.02	6505-8-10	7.58
	2	6502-8-8*	7.60	6505-8-12	15.75
(1) 37° MALE (2) 37° FEMALE LONG		6502-10-10*	11.24	6505-12-12	11.82
6500-L-4-4	16.31	6502-12-12*	13.89	6505-16-16	20.11
6500-L-6-6	12.85	6502-16-16*	24.20	6505-20-20	39.82
6500-L-8-8	20.47	6502-20-20*	45.47	6505-24-24	159.05
6500-L-10-10	28.67	6502-24-24*	74.31		
6500-L-12-12	26.62	6502-32-32	285.85		
6500-L-16-16	38.72				

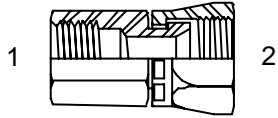
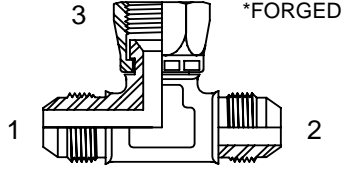
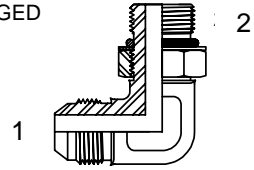
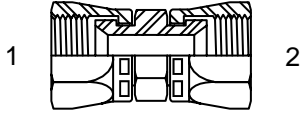
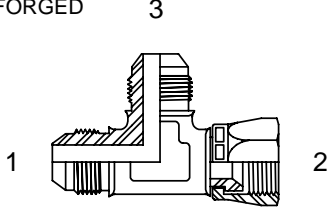
PART NO.	LIST EACH	PART NO.	LIST EACH	PART NO.	LIST EACH
 <p>(1) FEMALE PIPE (2) 37° FEMALE SWIVEL</p>		 <p>(1) (2) 37° MALE (3) 37° FEMALE SWIVEL</p>		 <p>(1) 37° MALE (2) MALE "O" RING</p>	
6506-2-4	12.13	6600-4-4*	6.20	6801-3-3*	31.27
6506-4-4	8.71	6600-5-5*	9.91	6801-4-2*	26.96
6506-4-6	8.91	6600-6-6*	6.76	6801-4-4*	4.98
6506-6-6	6.49	6600-8-8*	9.58	6801-4-5*	6.64
6506-6-8	9.16	6600-10-10*	13.58	6801-4-6*	6.20
6506-8-8	8.20	6600-12-12*	18.56	6801-4-8*	15.18
6506-8-6	8.42	6600-14-14	61.87	6801-5-4*	6.98
6506-8-10	9.78	6600-16-16*	30.62	6801-5-5*	6.58
6506-12-10	21.62	6600-20-20*	79.00	6801-5-6*	6.82
6506-12-12	12.84	6600-24-24	119.94	6801-6-4*	5.93
6506-16-16	23.22	6600-32-32	503.31	6801-6-5*	6.98
6506-20-20	49.31			6801-6-6*	5.62
6506-24-24	172.46			6801-6-8*	8.13
				6801-6-10*	10.71
				6801-6-12*	16.51
				6801-8-6*	7.67
				6801-8-8*	7.58
				6801-8-10*	10.27
				6801-8-12*	15.07
				6801-8-16	28.16
				6801-10-6*	12.20
				6801-10-8*	9.76
				6801-10-10*	10.51
				6801-10-12*	15.20
				6801-12-8*	13.47
				6801-12-10*	14.44
				6801-12-12*	14.73
				6801-12-14	25.29
				6801-12-16*	21.27
				6801-12-20	42.98
				6801-14-12	28.62
				6801-14-14*	25.00
				6801-16-10	33.11
				6801-16-12*	20.20
				6801-16-14	29.93
				6801-16-16*	21.38
				6801-16-20*	39.25
				6801-20-16*	36.62
				6801-20-20*	40.02
				6801-20-24	62.45
				6801-24-20*	59.74
				6801-24-24*	62.91
				6801-32-32	288.25
 <p>(1) (2) 37° FEMALE SWIVEL</p>		 <p>(1) (3) 37° MALE (2) 37° FEMALE SWIVEL</p>			
6565-4-4	12.52	6602-4-4*	6.64		
6565-6-6	13.81	6602-5-5*	10.31		
6565-8-8	15.39	6602-6-6*	7.07		
6565-10-10	16.22	6602-8-8*	10.09		
6565-12-12	22.13	6602-10-10*	14.11		
6565-16-16	68.48	6602-10-10-12	21.89		
6565-20-20	87.45	6602-12-12*	19.09		
		6602-14-14	38.25		
		6602-16-16*	29.76		
		6602-20-20*	58.76		
		6602-24-24	83.58		
		6602-32-32	342.70		

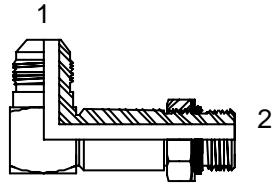
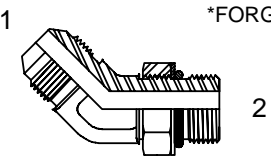
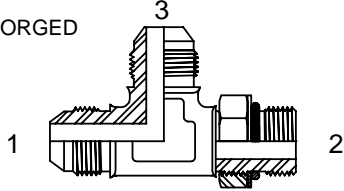
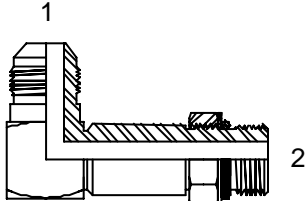
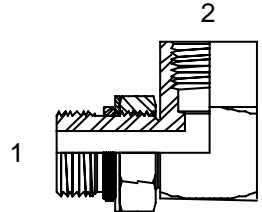
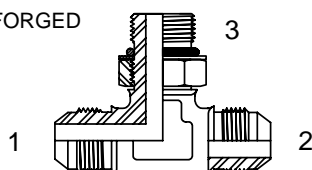
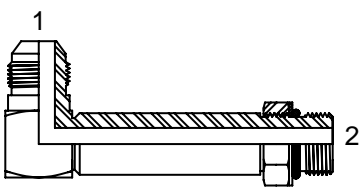
PART NO.	LIST EACH	PART NO.	LIST EACH	PART NO.	LIST EACH
					
(1) 37° MALE		(1) 37° MALE		(1-3) 37° MALE	
(2) MALE "O" RING LONG		(2) MALE "O" RING		(1) MALE "O" RING	
6801-L-4-4	10.61	6802-4-4*	6.82	6804-4-4*	8.29
6801-L-6-6	7.47	6802-4-6*	13.18	6804-5-5*	10.44
6801-L-8-8	11.98	6802-5-5*	9.22	6804-6-6*	8.31
6801-L-10-10	14.22	6802-6-6*	7.13	6804-6-8-6	27.23
6801-L-12-12	20.80	6802-6-4*	10.76	6804-8-8*	11.11
6801-L-16-16	48.36	6802-6-8*	8.93	6804-10-10*	15.16
6801-L-20-20	114.66	6802-8-8*	8.87	6804-12-10	21.98
		6802-8-6*	9.91	6804-12-12*	20.47
(1) 37° MALE		6802-8-10*	11.69	6804-14-14	50.62
(2) MALE "O" RING X-LONG		6802-10-8*	13.00	6804-16-10	18.68
6801-LL-4-4	10.85	6802-10-10*	11.18	6804-16-16*	35.89
6801-LL-6-6	8.58	6802-10-12*	16.62	6804-20-20*	61.62
6801-LL-8-8	12.09	6802-12-10*	18.33	6804-24-24	86.05
6801-LL-8-6	12.53	6802-12-12*	15.07		
6801-LL-10-10	20.89	6802-12-14	39.87		
6801-LL-12-12	18.91	6802-12-16*	25.31	(1) MALE "O" RING	
6801-LL-16-16	23.80	6802-14-14	38.27	(2) FEMALE PIPE	
6801-LL-20-20	175.91	6802-16-12*	23.45	6805-4-2	6.51
		6802-16-16*	23.22	6805-4-4	9.93
		6802-16-20*	40.35	6805-5-2	9.36
		6802-20-20*	41.27	6805-6-4	7.60
		6802-24-24*	62.67	6805-6-6	10.04
		6802-32-32	258.12	6805-8-6	9.47
		*FORGED		6805-8-8	23.69
				6805-10-8	14.38
		(1-2) 37° MALE		6805-12-12	19.36
		(2) MALE "O" RING		6805-14-12	58.89
		6803-4-4*	7.18	6805-16-16	30.02
		6803-5-5	10.56	6805-20-20	50.76
		6803-6-6*	7.93	6805-24-24	88.58
		6803-8-8*	10.64		
		6803-10-10*	15.47		
		6803-12-12*	20.47		
		6803-12-10*	9.40		
		6803-14-14	69.71		
		6803-16-16*	33.22		
		6803-20-20*	76.85		
		6803-24-24	100.89		
					
(1) 37° MALE					
(2) MALE "O" RING XX-LONG					
6801-LLL-6-6	23.35				
6801-LLL-8-8	27.30				

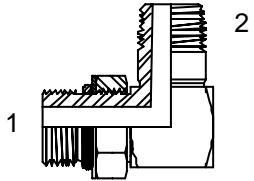
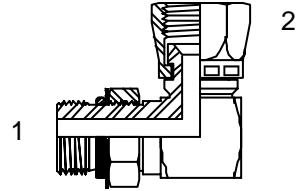
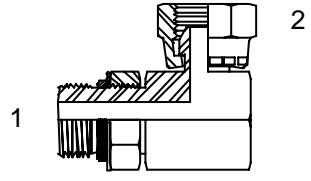
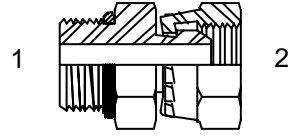
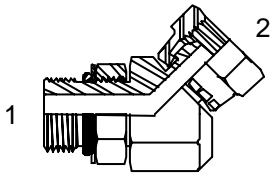
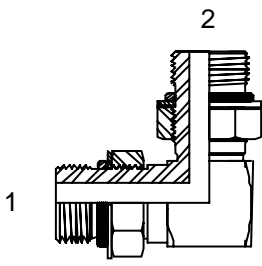
PART NO.	LIST EACH	PART NO.	LIST EACH	PART NO.	LIST EACH
					
(1) MALE "O" RING (2) MALE PIPE		(1) ADJ. "O" RING (2) 37° FEMALE SWIVEL		(1) MALE "O" RING (2) FEMALE PIPE SWIVEL	
6806-4-2	6.69	6809-4-4	10.82	6901-4-4	7.47
6806-4-4	8.96	6809-6-6	11.62	6901-4-6	18.99
6806-5-2	9.76	6809-8-8	17.00	6901-6-4	7.91
6806-6-4	7.07	6809-10-10	18.60	6901-6-6	8.38
6806-6-6	12.76	6809-12-10	32.22	6901-6-8	14.13
6806-8-6	9.33	6809-12-12	30.87	6901-8-6	9.18
6806-8-8	13.98	6809-16-16	43.78	6901-8-8	10.04
6806-10-8	13.18	6809-20-20	80.83	6901-8-12	20.80
6806-12-12	19.02			6901-10-6	11.27
6806-14-12	39.93			6901-10-8	11.16
6806-16-16	31.33	(1) MALE "O" RING (2) FEMALE PIPE SWIVEL		6901-10-12	21.47
6806-20-20	45.76	6900-4-4	3.47	6901-12-8	14.87
6806-24-24	70.94	6900-5-4	5.24	6901-12-12	16.89
		6900-6-4	3.44	6901-14-12	32.60
		6900-6-6	3.69	6901-16-12	27.16
		6900-6-8	6.69	6901-16-16	27.93
		6900-8-4	8.53	6901-16-20	79.33
		6900-8-6	3.91	6901-20-12	90.98
		6900-8-8	4.31	6901-20-20	60.20
		6900-8-12	8.38	6901-24-24	161.03
		6900-8-12	8.38	6901-32-32	391.95
		6900-10-6	6.18		
		6900-10-6	6.18		
		6900-10-8	5.27	(1) MALE "O" RING (2) FEMALE PIPE SWIVEL	
		6900-10-8	5.27	6902-4-4	11.33
		6900-10-12	7.73	6902-6-4	12.27
		6900-12-8	8.22	6902-6-6	11.64
		6900-12-12	7.80	6902-8-6	13.16
		6900-12-16	19.25	6902-8-8	12.71
		6900-14-12	16.78	6902-8-12	36.40
		6900-16-12	14.53	6902-10-6	14.00
		6900-16-16	12.33	6902-10-8	12.71
		6900-16-16	12.33	6902-10-12	23.91
		6900-20-16	28.02	6902-12-12	20.80
		6900-20-20	31.02	6902-12-16	60.40
		6900-24-20	65.25	6902-16-16	30.60
		6900-24-24	72.38	6902-20-20	116.16
		6900-24-24	72.38	6902-24-24	183.59
		6900-32-32	193.72		
					
(1-2) ADJ. "O" RING					
6807-4-4	11.98				
6807-6-6	11.69				
6807-8-8	15.98				
6807-10-10	21.36				
6807-12-12	28.11				
6807-16-16	43.20				
6807-20-20	71.82				
6807-24-24	109.29				